

Data Sheet

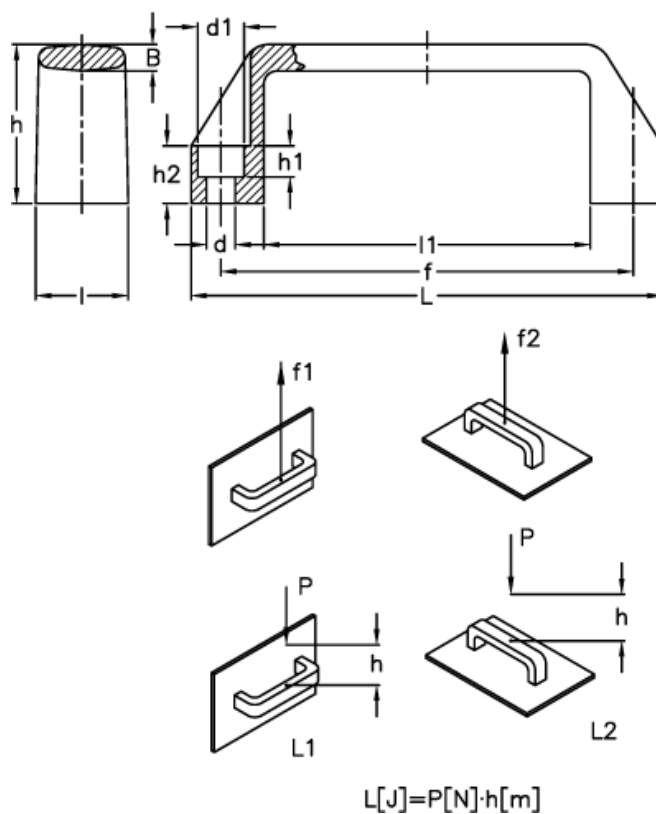

Article number: 2304037152
Description: E+G Handle
M.443/150-CH, Orange

Measures



$$L[J]=P[N] \cdot h[m]$$

B	$= 7.0$	$h2$	$= 16$
d	$= 8.5$	l	$= 27$
$d1$	$= 13.5$	L	$= 150$
f	$= 132 \pm 1$	$l1$	$= 108$
$F1 (N)$	$= 3500$	$L1 (J)$	$= 27$
$F2 (N)$	$= 2500$	$L2 (J)$	$= 14$
h	$= 45$		
$h1$	$= 8.5$		